

TECHNICAL INSTRUCTIONS
FOR
SAFETY RECALL G0V
REAR LOWER SUSPENSION ARM No.1
2006 – EARLY 2011 MODEL YEAR RAV4

The repair quality of covered vehicles is extremely important to Toyota. All dealership technicians performing this recall are required to successfully complete the most current version of the E-Learning course "Safety Recall and Service Campaign Essentials". To ensure that all vehicles have the repair performed correctly; technicians performing this recall repair are required to currently hold at least one of the following certification levels:

- Toyota Expert Chassis
- Master
- Master Diagnostic Technicians

It is the dealership's responsibility to select technicians with the above certification level or greater to perform this recall repair. Carefully review your resources, the technician skill level, and ability before assigning technicians to this repair. It is important to consider technician days off and vacation schedules to ensure there are properly trained technicians available to perform this repair at all times.

I. OPERATION FLOW CHART

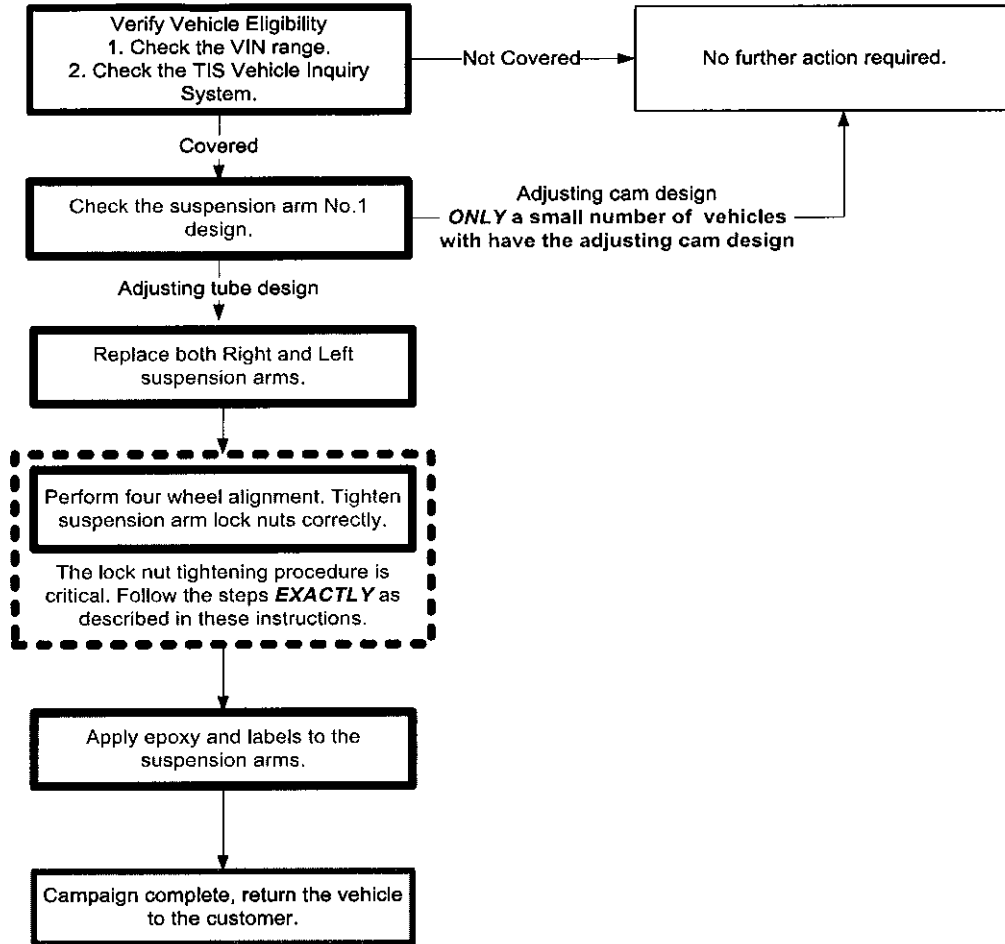

I. BACKGROUND

In the earlier action, if the nuts for adjusting rear wheel alignment were improperly tightened when an alignment was performed, rust could form on suspension arm threads. If this occurs, and if the condition is not identified and remedied during servicing or repair under the existing remedy procedure, the threads can wear over time, causing the arm to separate, which could result in a loss of vehicle control.

II. PREPARATION

A. PARTS

Part Number	Part Description	Quantity
00289-SW1KT-DS	Epoxy Kit	1
*The kit above includes the following parts.		
-	50ml Epoxy Cartridge	1
-	Mixing Nozzle	1
-	Caution Labels	2

All vehicles will require this epoxy kit.

Part Number	Part Description	Quantity
04002-22142	Rear Suspension Arm No.1 Kit*	2
*The kit above includes the following parts.		
48710-0R010	Rear Lower Suspension Arm No.1	1
90179-12027	Nut	1

This part will be replaced on both the right and left side on all vehicles. Therefore order two kits per vehicle.

B. TOOLS & EQUIPMENT

- Standard hand tools
- Torque wrench
- 22mm crowfoot
- 4 Wheel alignment machine



C. MATERIALS

- FIGP 00295-00103 – Needed if voids are found in the epoxy, follow these instructions for details
- Frekote Liff Mold Release 00289-HKLMR-DS – Quantity: 1 can, one can will cover approximately 75 vehicles

SST – This is an essential special service tool that the dealership should have.

Part Number	Part Name	Quantity
09960-20012	Ball Joint Puller Set	1

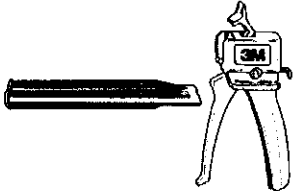
CAMPAIGN TOOLS – These tools are provided to the dealership. These tools are necessary when performing this repair.

Image	Name	Quantity
	Epoxy Mold Set	4 halves / 2 complete molds
	Epoxy Applicator	1
	22mm Crowfoot	1

NOTE: These tools **CANNOT** be ordered through the parts or tools system. There is a very limited supply of tools, but if additional tools are needed, contact your regional representative

III. IDENTIFICATION OF AFFECTED VEHICLES

NOTE:

- Check the TIS Vehicle Inquiry System to confirm the VIN is involved in this Safety Recall, and that the campaign has not already been completed prior to dealer shipment or by another dealer.
- TMS warranty will not reimburse dealers for repairs conducted on vehicles that are not affected or were completed by another dealer.

IV. COMPONENTS

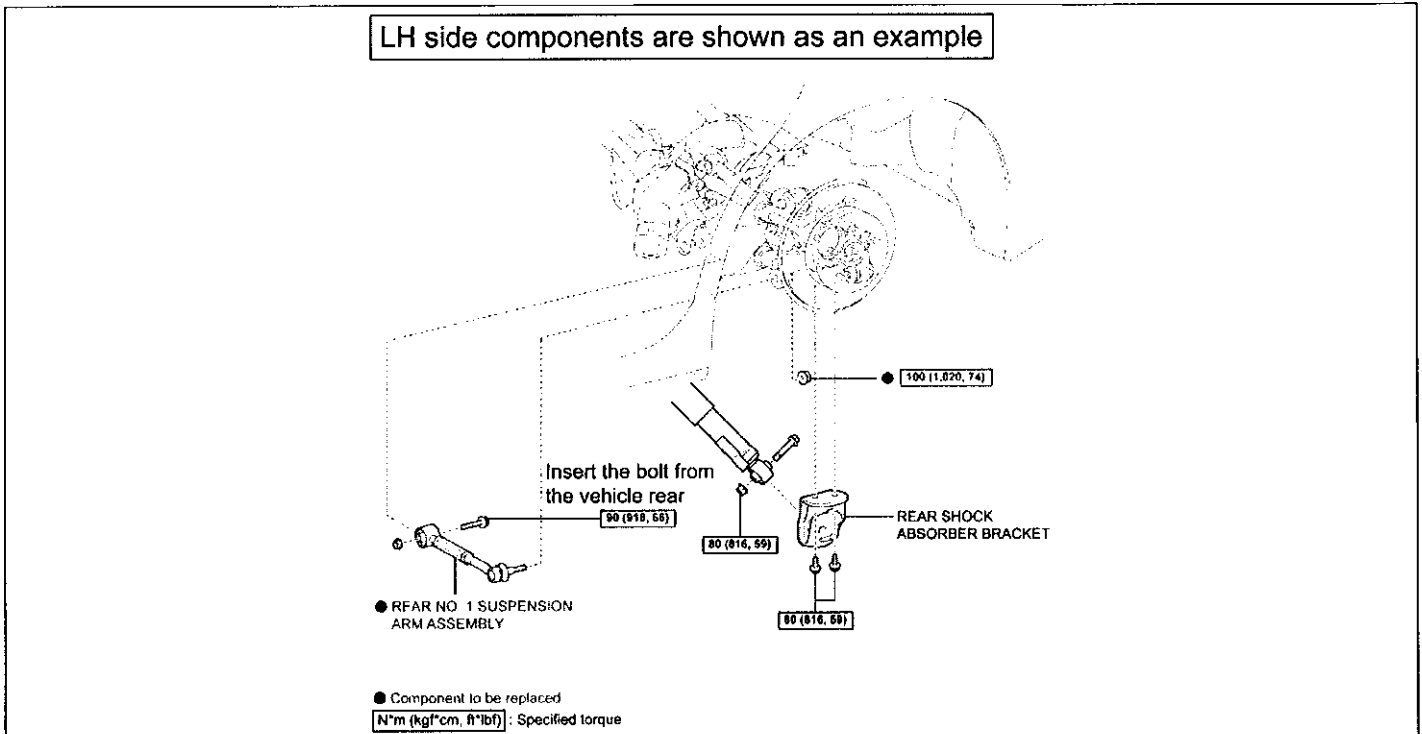

V. REAR LOWER SUSPENSION ARM No.1 INSPECTION

1. CHECK THE SUSPENSION ARM DESIGN

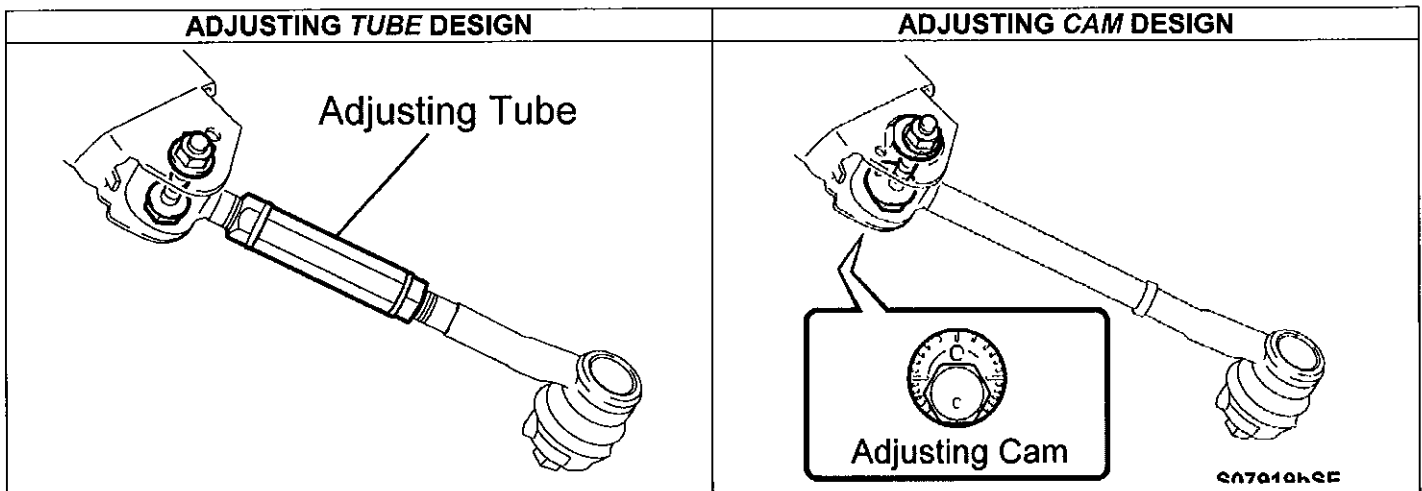

ARM DESIGN	ACTION REQUIRED
Adjusting Tube	Proceed to STEP 2. CHECK FOR LOOSENESS VISUALLY AND BY HAND
Adjusting Cam	No further action required. Campaign complete.

VI. REPLACE BOTH REAR NO.1 SUSPENSION ARMS



Note: Remedy has changed. Remedy now requires both the right and left Rear No. 1 Suspension Arms to be replaced on all vehicles.

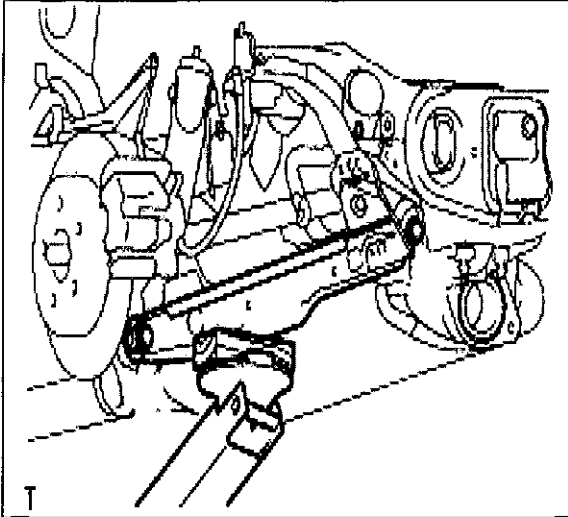

1. REAR NO.1 SUSPENSION ARM ASSEMBLY REMOVAL

a) Support the No.2 suspension arm.

b) Remove the bolt and nut from the suspension member by holding the nut and loosening the bolt.

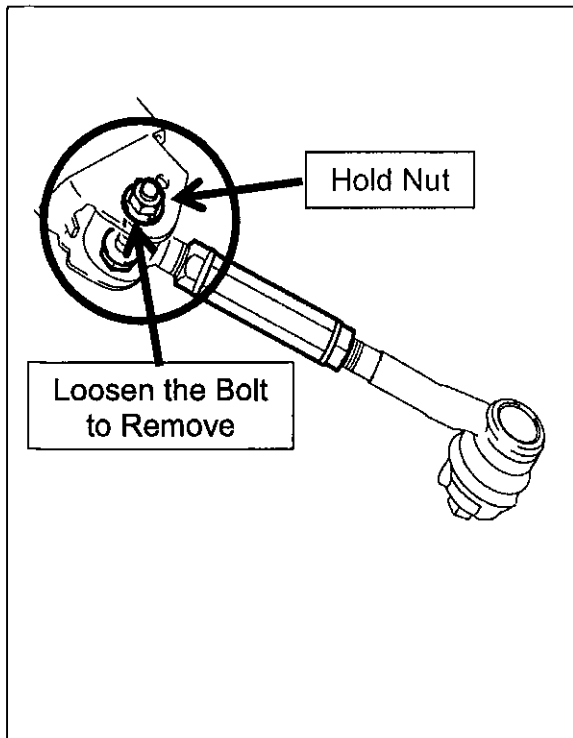

NOTE: The nut securing the bolt to the suspension member is serrated.



DO NOT loosen the nut on the suspension member side. Always hold the nut and loosen the bolt.

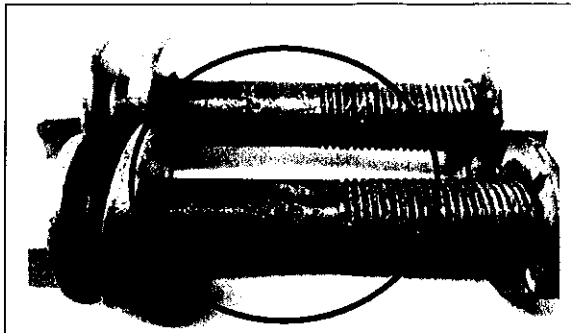

Note: If the bolt was seized in the bushing, it may be damaged along with the nut. Replace as needed.
Bolt part number (90119-A0328 or 91672-L1265)
Nut part number (90080-17221 or 90178-12009)

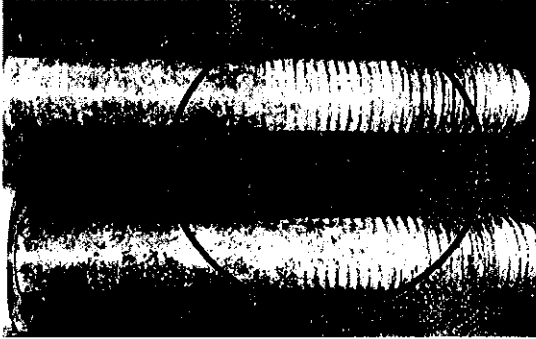

- c) Carefully inspect the bolt for excessive rust or pitting and replace as necessary.

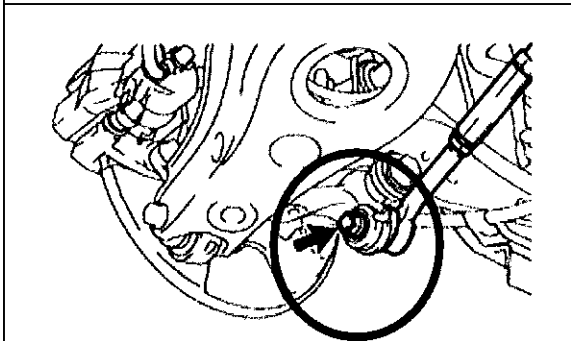

- d) Remove the nut securing the No.1 rear suspension arm ball joint to the axle carrier.

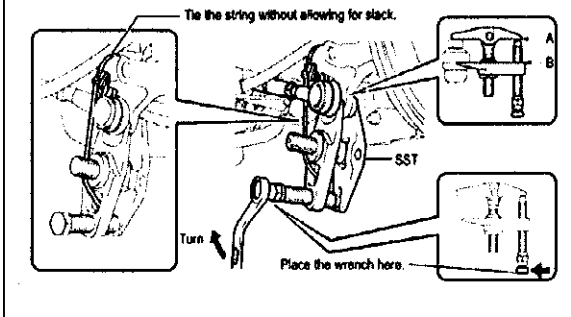

- e) Using the ball joint puller SST, disconnect the suspension arm from the axle carrier.

SST: 09610-20012

2. REAR NO.1 SUSPENSION ARM ASSEMBLY INSTALLATION (both right and left arms)

- a) Temporarily install the suspension arm by installing the bolt from the rear of the vehicle into the suspension member and rear No.1 suspension arm assembly.
- b) Insert the ball joint stud into the axle carrier and hand tighten the nut onto the stud.

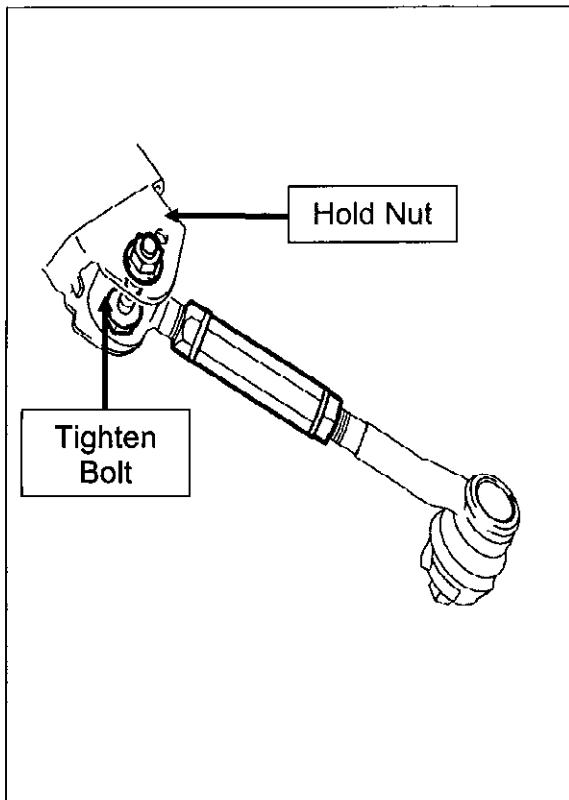

- c) Lower the vehicle and place the weight of the vehicle onto the suspension.

NOTE: To prevent stress on the new suspension arm bushing, apply a load to the suspension system to confirm the suspension arm bushing is aligned correctly when tightening. The rear No.1 suspension arm should be level with the ground.

- d) Install the nut by hand onto the bolt securing the arm to the suspension member.
- e) Torque the bolt to spec while holding the nut.
Torque: Bolt: 90 N-m (918 kgf-cm, 66 lbf)



DO NOT tighten the nut on the suspension member side. Always hold the nut and tighten the bolt.

- f) Torque the ball joint nut to spec.
Torque: Nut: 100 N-m (1020 kgf-cm, 74 lbf)

NOTE: Suspension arm adjustment and tightening procedure is critical. After replacing the arm, refer to SECTION VIII. in these instructions for this procedure.

VII. SUSPENSION ARM ADJUSTMENT AND LOCK NUT TIGHTENING

Video Supplement: Suspension Arm Adjustment and Lock Nut Tightening steps

1. JOUNCE THE REAR OF THE VEHICLE

- a) Due to the pressure applied to the rear suspension system during inspection, it is **CRITICAL** to jounce the rear of the vehicle to reset the suspension prior to vehicle alignment.



Note: To ensure proper alignment and torque specifications are achieved, make sure the equipment (Alignment machine and Torque Wrenches) are properly calibrated and cleaned on a regular basis.

2. PERFORM FOUR WHEEL ALIGNMENT

- a) Perform alignment using an alignment machine



Note: To ensure rear toe-in stays within specification after normal suspension movement, make sure to set the measurement as close to the middle of the spec as possible.

- b) Test drive the vehicle to confirm the alignment.



- Holding the adjusting steady tube is **CRITICAL** when tightening the lock nuts, if the adjusting tube is not held steady the lock nuts may become loose.
- The alignment **MUST** be performed by the same technician performing the recall. Only one person should perform the entire recall on each vehicle.
- The tightening procedure for these lock nuts is critical, failure to tighten them in the correct order could cause them to become loose.

VITAL STEPS

3. TIGHTEN THE LOCK NUTS EXACTLY AS DESCRIBED BELOW

Use a 22mm combination wrench and a 22mm crowfoot attached to a torque wrench

Tightening Sequence: 1. Inboard 2. Outboard 3. Inboard Again

Torque: 41ft. lbf (56N·m)

- Tighten the inboard lock nut. **Hold the adjusting tube steady** and tighten the **inboard lock nut** to the specified torque.
- Tighten the outboard lock nut. **Hold the adjusting tube steady** and tighten the **outboard lock nut** to the specified torque.
- Tighten the inboard lock nut again. **Hold the adjusting tube steady** and tighten the **inboard lock nut** to the specified torque.

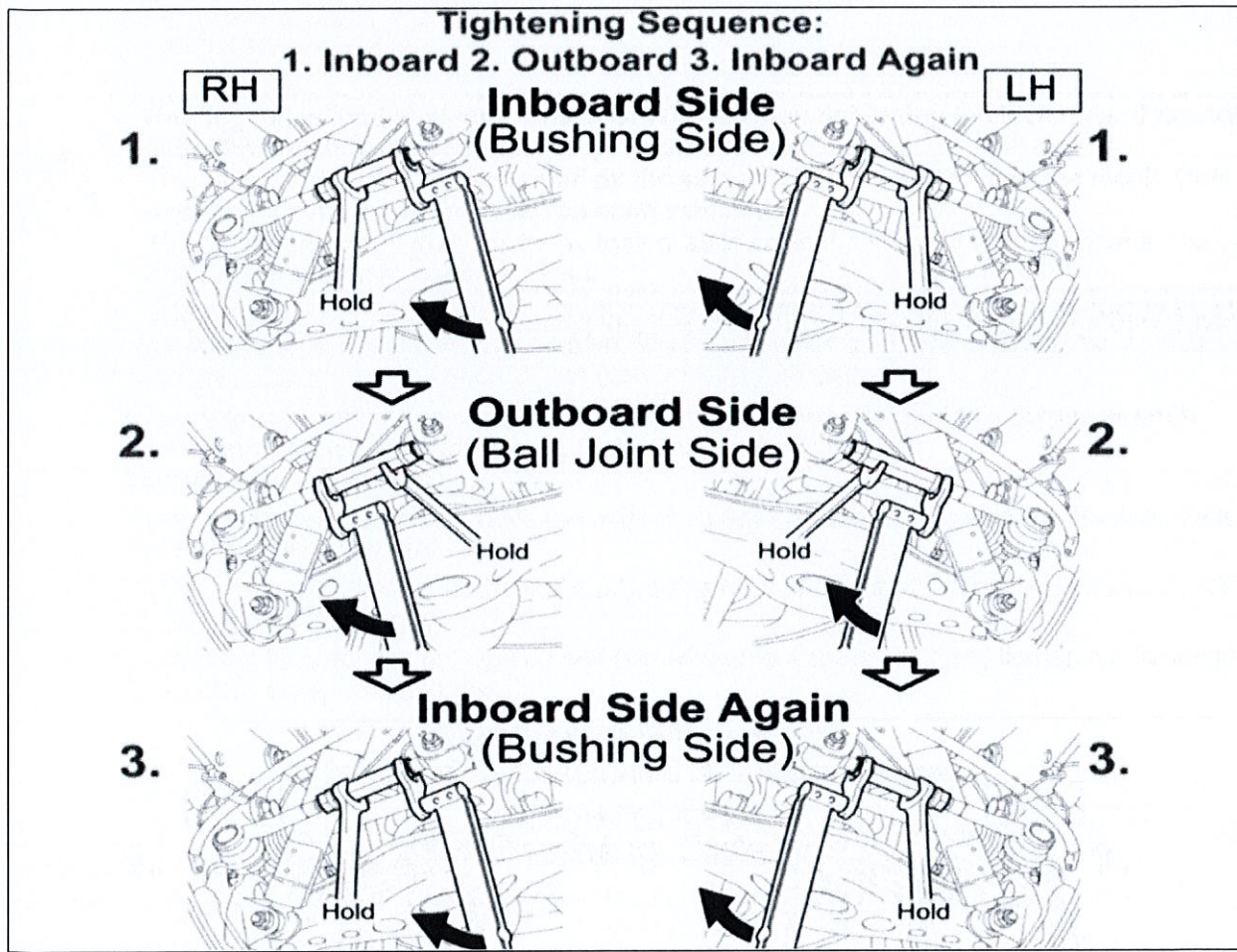

VIII. SUSPENSION ARM EPOXY APPLICATION

Video Supplement: Epoxy Application steps

STOP

Confirm the thread inspection, vehicle alignment, and lock nut tightening have all been performed correctly before proceeding.

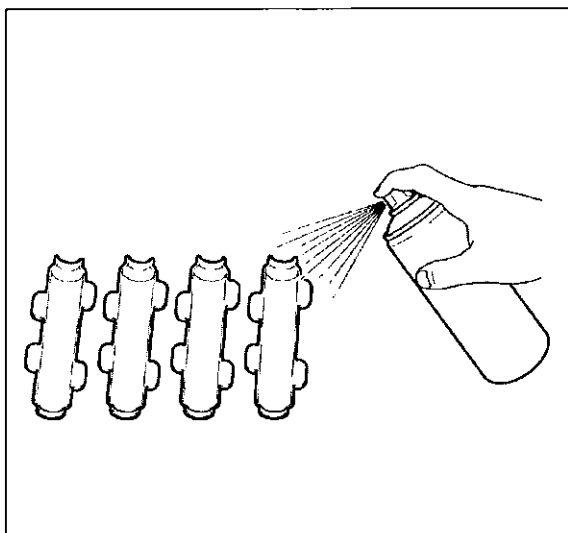

1. PREPARE THE EPOXY MOLDS

- Confirm there is no dried epoxy or debris in the molds.
- If there is dried epoxy in the molds, use brake clean and a rag or soft bristled brush to clean the epoxy. **DO NOT** use a metal brush or anything that may damage the mold.
- Hold the can about 8 inches from the molds, and apply two light coats of the mold release to the molds.
- Once the mold release has dried, there should not be wet pools in the molds.

STOP

- DO NOT** spray the mold release near any vehicle electrical components or they may be damaged, refer to [T-SB-0101-11](#) for more details.
- The mold release typically takes approximately 60 seconds to set, but may take longer depending on temperature.

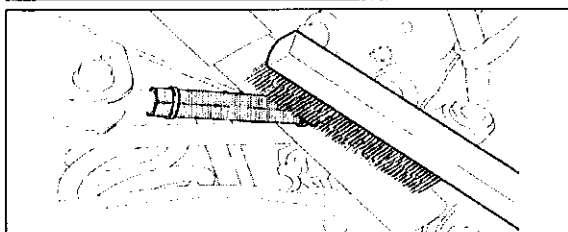

2. CLEAN THE SUSPENSION ARM

- Clean the area of the arm where the epoxy will be applied.
- Use a steel bristle brush to remove any rust buildup and flaking that may be present on the arm.

NOTE: DO NOT use power tools as they could damage the arm.

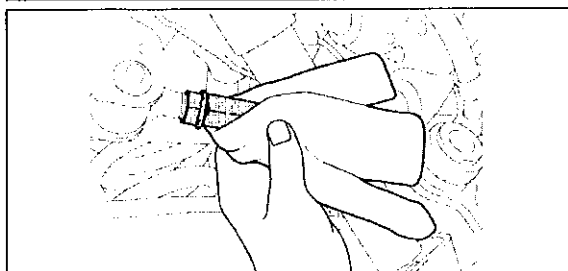

- Use a rag and brake clean to finish cleaning the arm.

STOP

Cleaning the exterior surface, even on a new arm, is **CRITICAL** to confirm the epoxy adheres properly.

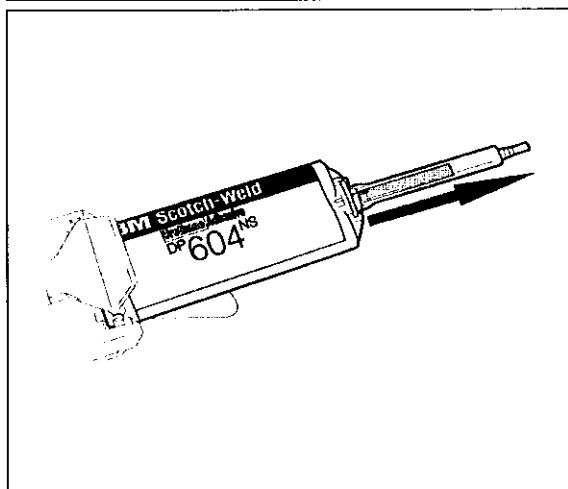

3. FILL THE MOLDS WITH EPOXY

Confirm the mold release has dried to a waxy film, if any wet mold release is still present the epoxy will stick to the molds.

- Assemble the applicator by following the instructions included in the applicator box.
- Install the epoxy cartridge in the applicator.
- Install the mixing nozzle to the cartridge.
- Start by squeezing the handle to pre-fill the mixing tube until the epoxy reaches the end of the nozzle, then stop squeezing.

STOP

Pre-filling the mixing nozzle is critical to ensure the molds are each filled with even amounts of epoxy in the following steps.

NOTE: Confirm the one-to-one ratio plunger is installed in the applicator.

4. FILL THE MOLDS WITH EPOXY

STOP

- One complete epoxy cartridge should be used for every 2 suspension arms.
- There are approximately 12 full squeezes of epoxy in each cartridge.
- Follow these steps exactly as described so there are no voids in the epoxy when installed on the suspension arm.

a) Apply two full squeezes of the epoxy along the length of each mold. (eight total squeezes)

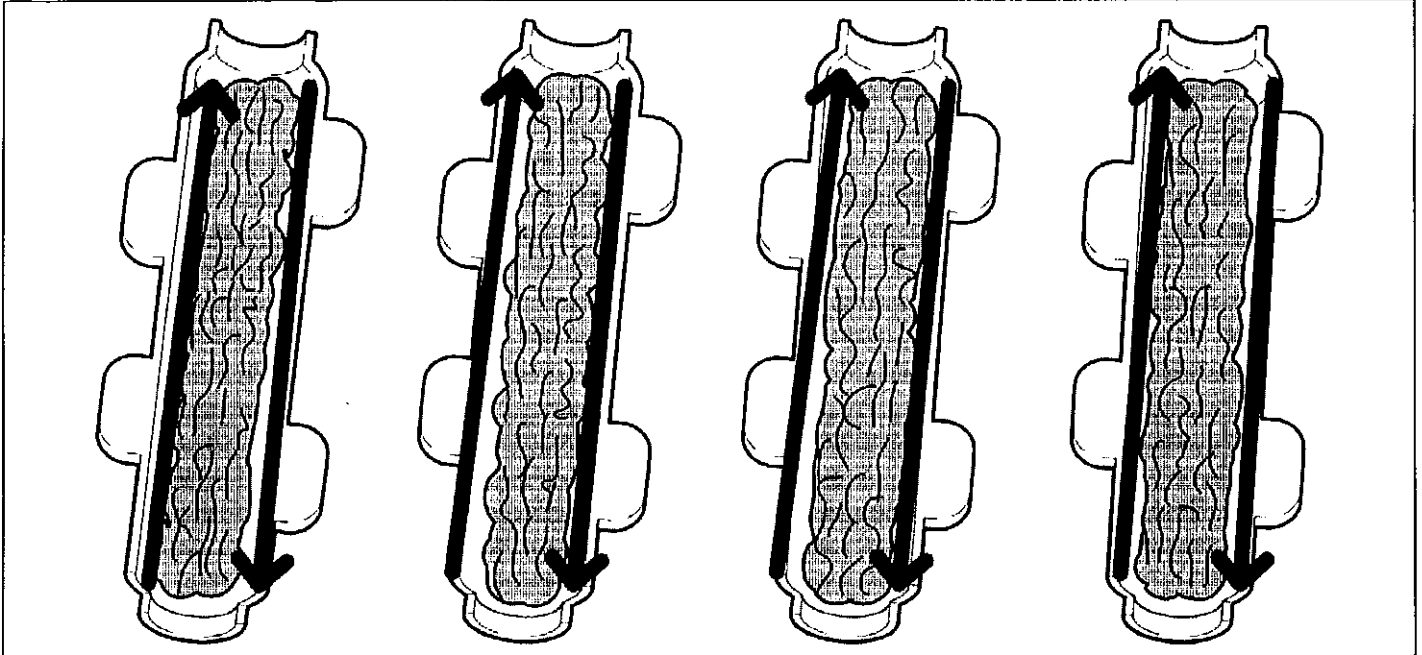

b) Apply the remaining 3-4 squeezes evenly in the upper and lower thirds of the molds.

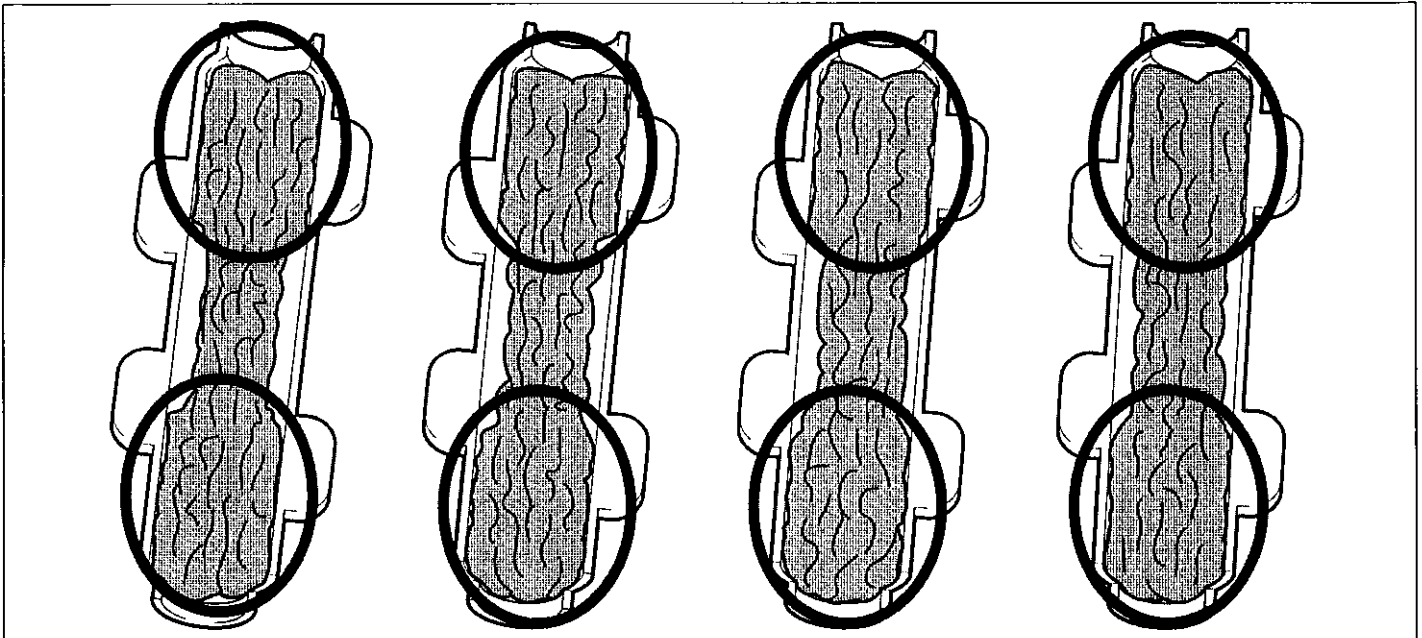

STOP

- It is important that the epoxy is filled evenly between the four mold halves.
- If the molds have an uneven amount of epoxy, pair the mold with the least amount of epoxy and the one with the most epoxy together to avoid creating voids in the epoxy once it sets.

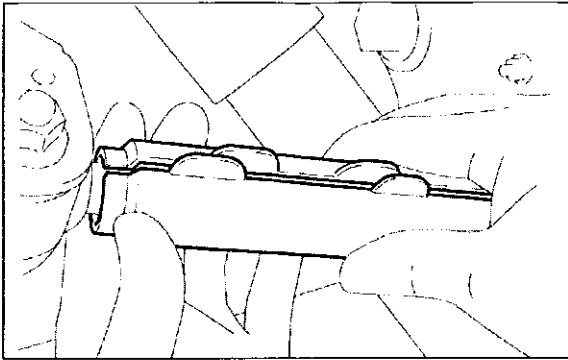

5. INSTALL THE MOLDS ON THE SUSPENSION ARMS

- a) Confirm the molds are centered over the adjusting tube and lock nuts, then place them on the arm.
- b) Press the mold halves together and confirm the edges of the mold halves are aligned with each other.



The mold should be installed within 5 minutes of dispensing the epoxy to ensure the epoxy adheres properly.

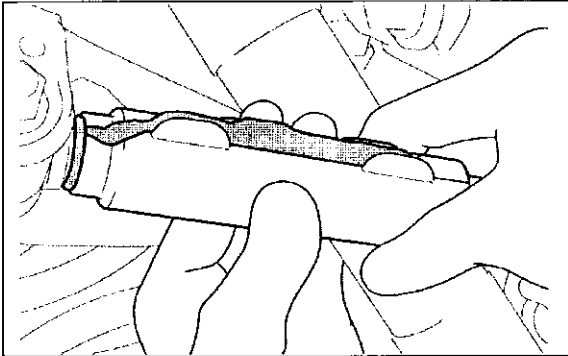

- c) The epoxy should be forced out evenly along the parting lines to indicate a good fill.
- d) There is **NO NEED** to wipe the epoxy along the parting lines, it can be trimmed easily once it has set.

NOTE: There is no need to clamp the molds, the epoxy will hold the molds in place.

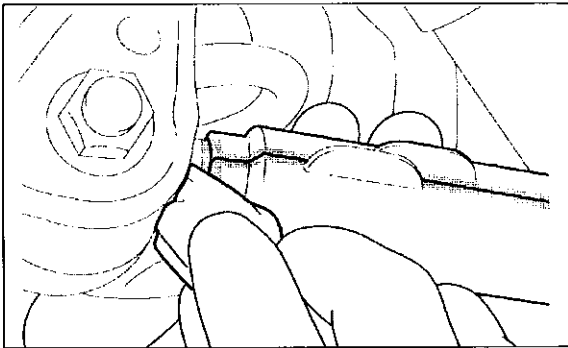

- e) Confirm the epoxy at the ends of the mold is clean and smooth.

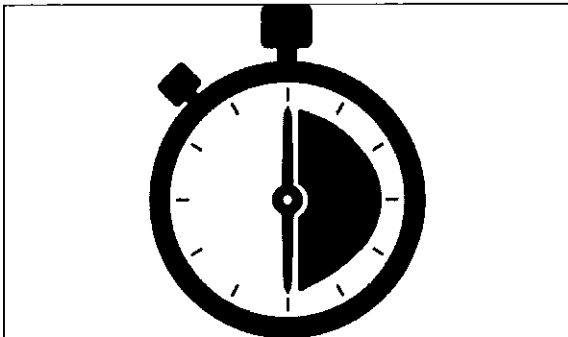

6. ALLOW THE EPOXY TO SET

- a) Allow the epoxy to set for at least 30 minutes.



- The set time is temperature dependent, it will take longer in cold temperatures.
- In temperatures below 50°F it may take 60 minutes or longer and in temperatures below 0°F it may take 90 minutes or longer.
- **DO NOT** apply heat to speed the set time.

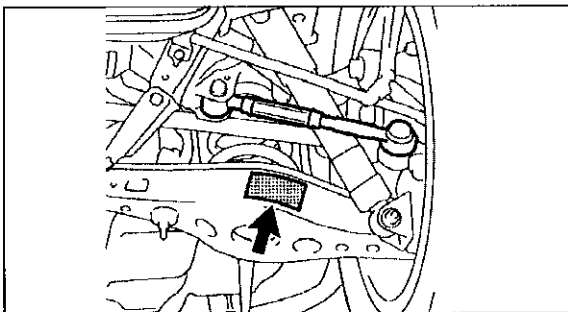

7. REMOVE THE CAUTION LABELS FROM SUSPENSION ARM No.2

- a) Remove the labels from the front and back sides of suspension arm No.2.

NOTE:

- This step only needs to be performed if recall C0J was previously performed and caution labels are installed.
- It may be necessary to heat the labels with a heat gun to ease the removal process.

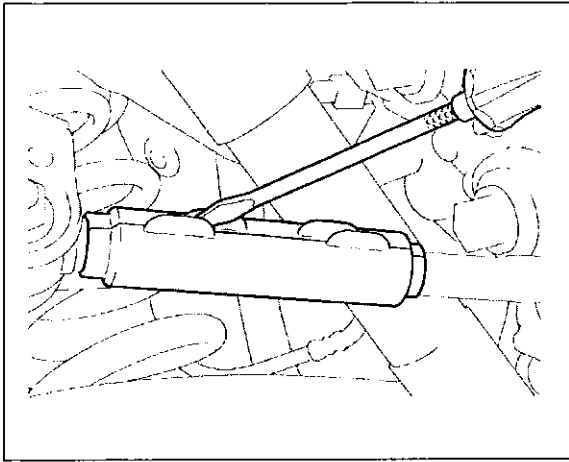

8. REMOVE THE MOLDS

- a) If temperatures are cold, confirm the epoxy has set by touching it prior to removing the molds.
- b) After the epoxy has set for a minimum of 30 minutes, the molds can be removed.
- c) Use a screwdriver on the mold tabs to remove the molds.

STOP

- **DO NOT** remove the molds early or the epoxy may be damaged.
- **DO NOT** twist the molds during removal, this may deform the epoxy.
- It is normal for the epoxy to still be flexible, the epoxy will continue to cure over the next 6-8 hours.

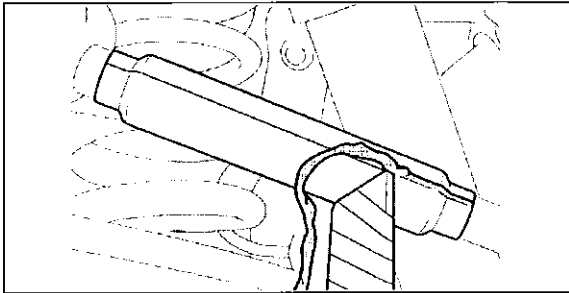

9. TRIM AND CLEAN THE EPOXY

- a) Trim the excess epoxy from the parting lines using a razor.

NOTE: The excess epoxy MUST be trimmed to confirm the caution label adheres properly.

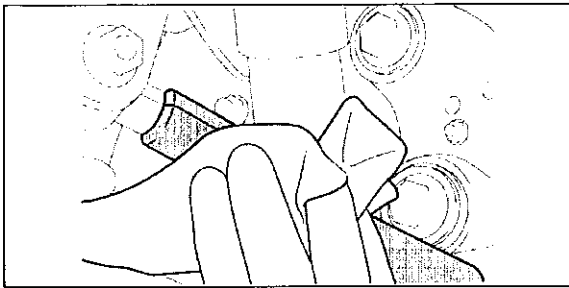

- b) Wipe the epoxy clean using a shop cloth to remove any remaining mold release.

STOP **DO NOT** use brake clean on the epoxy.

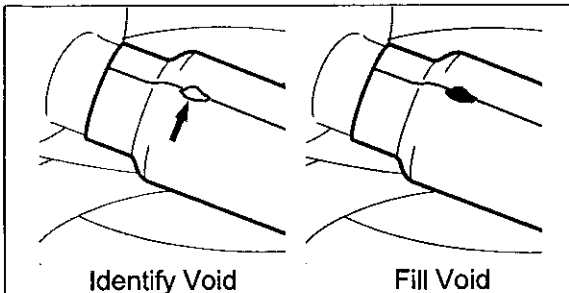

10. INSPECT FOR VOIDS

- a) Inspect the epoxy for any voids that expose the arm.
- b) If any voids are identified, fill with FIPG.

STOP There should not be any voids that expose the arm if the molds are filled with epoxy correctly.

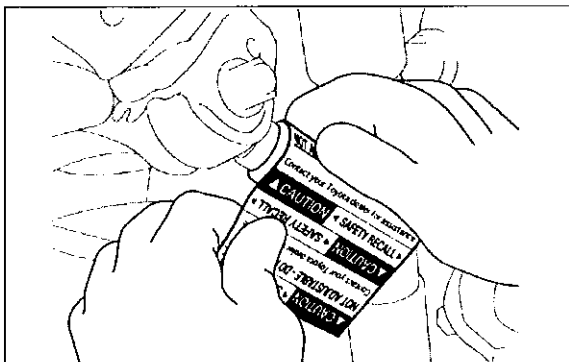

11. APPLY CAUTION LABEL

- a) Wrap the caution label around the epoxy.

NOTE: The label is designed to overlap over itself by approximately 3/8".

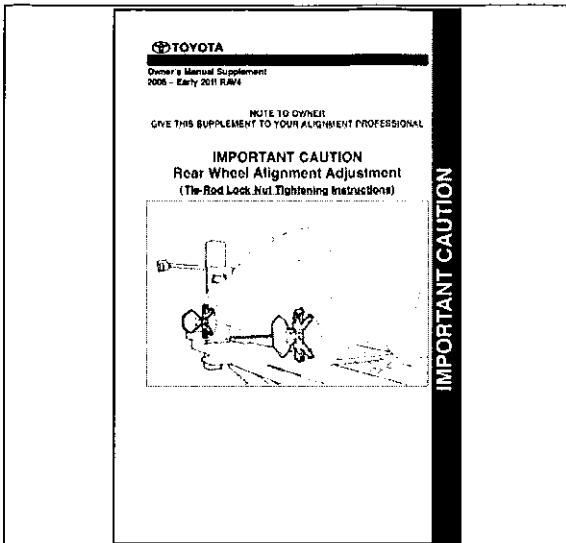

12. REMOVE THE OWNER'S MANUAL SUPPLEMENT

- a) Remove and discard the owner's manual supplement located in the glove box.

NOTE: This step only needs to be performed if recall C0J was previously performed and owner's manual supplement can be found in the glove box.

13. CAMPAIGN COMPLETE

◀ VERIFY REPAIR QUALITY ▶

- Confirm **ALL** inspection steps are followed **EXACTLY** as described in these instructions
- Confirm the lock nut tightening procedure is followed **EXACTLY** as described in these instructions if the arm is being replaced
- Confirm vehicle alignment is correct prior to applying epoxy to the arm
- Confirm the epoxy is applied correctly and that the caution label is installed

If you have any questions regarding this update, please contact your regional representative.

IX. APPENDIX

A. CAMPAIGN DESIGNATION DECODER

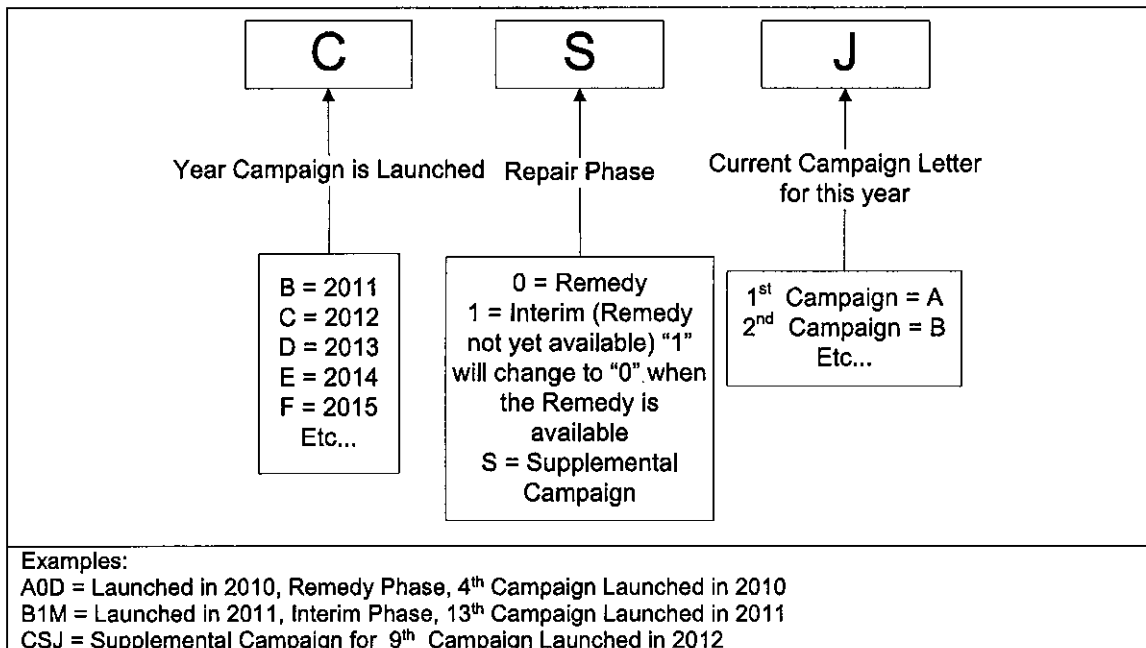

B. CAMPAIGN PARTS DISPOSAL

Make sure all campaign parts (original parts) removed from the vehicle are disposed of in a manner in which they will not be reused, **unless requested for parts recovery return.**